

SdKfz 251 ausf C Assembly Instructions

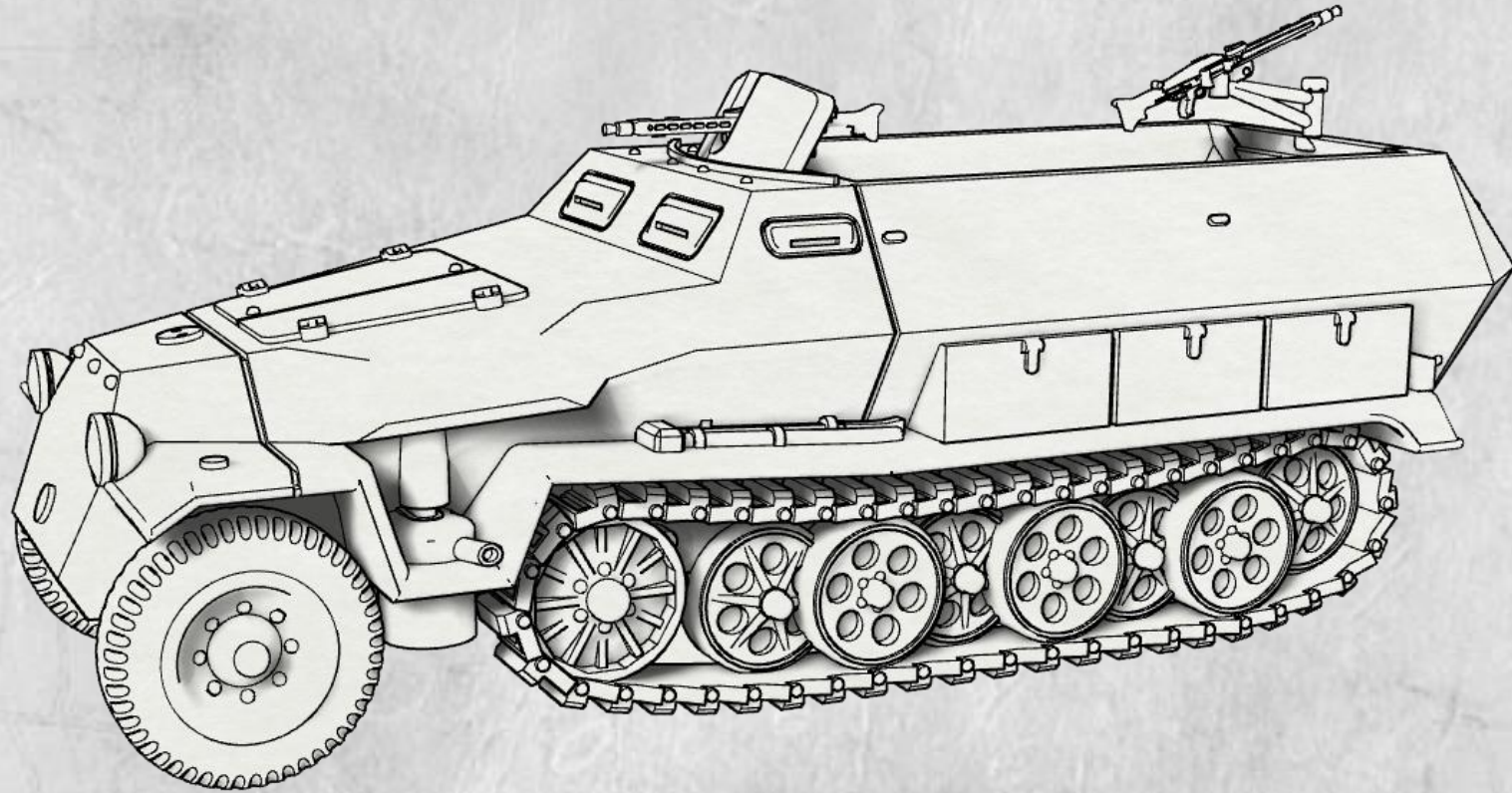

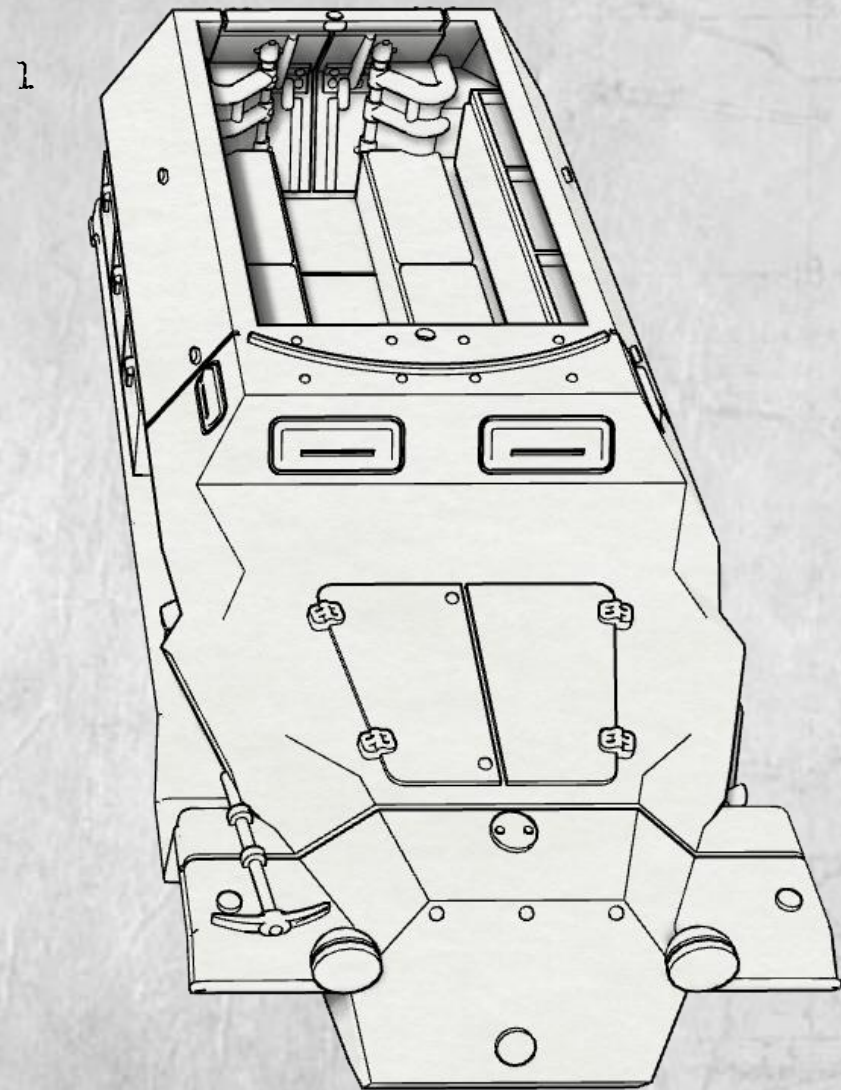

8 (x2) 9 (x2) 10

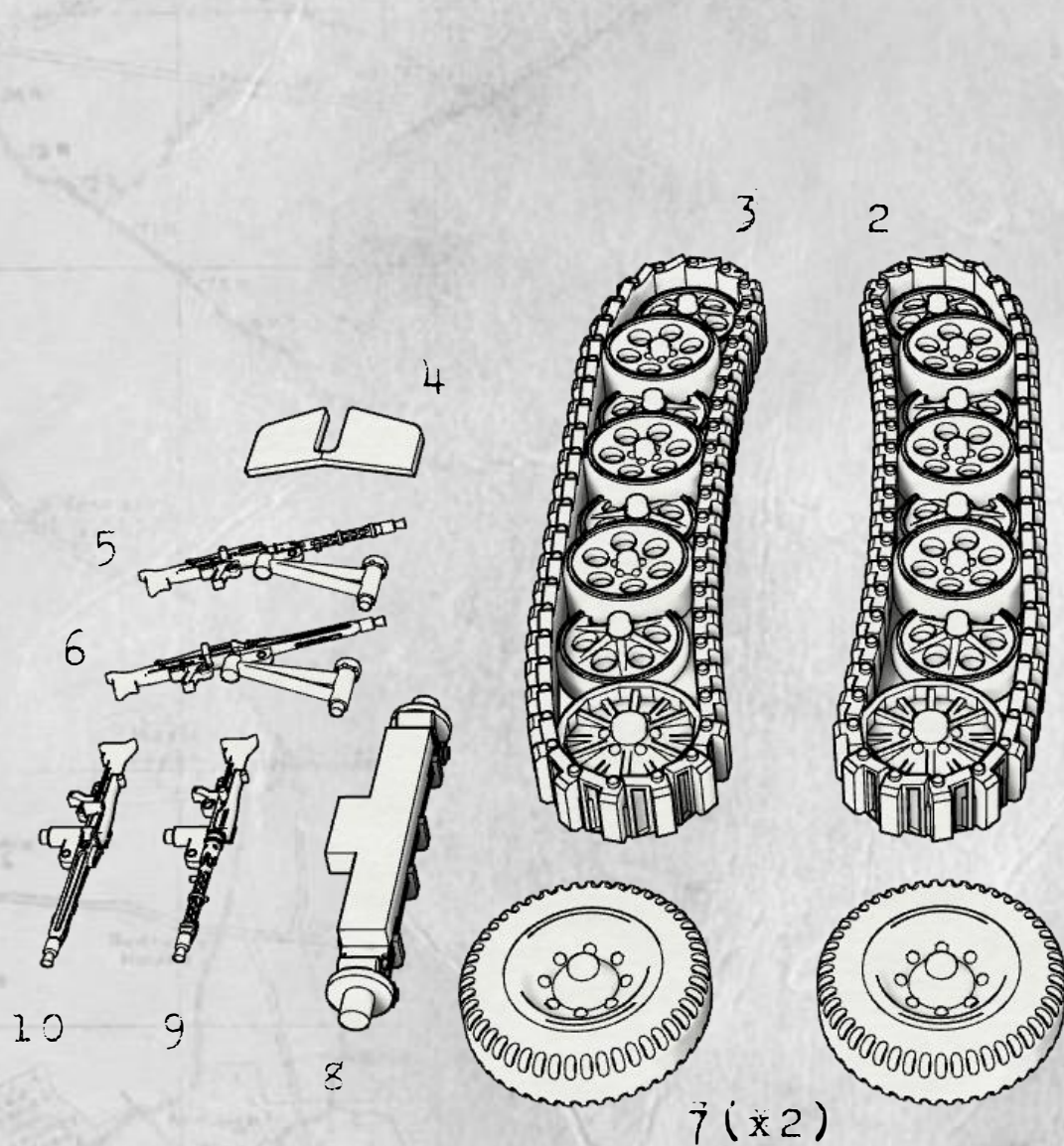

Trench Worx



### Step One

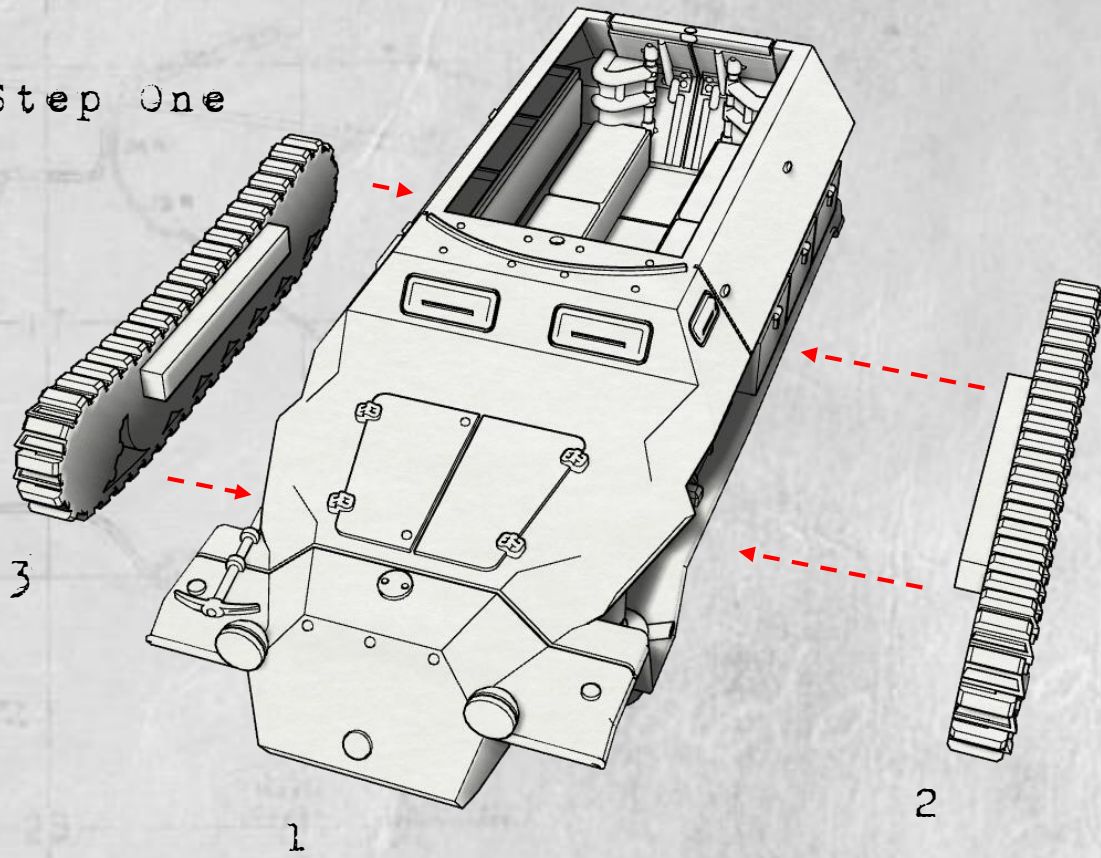

We recommend you sand the connecting points before gluing the parts in place. This will make for a stronger bond.

### Step Two

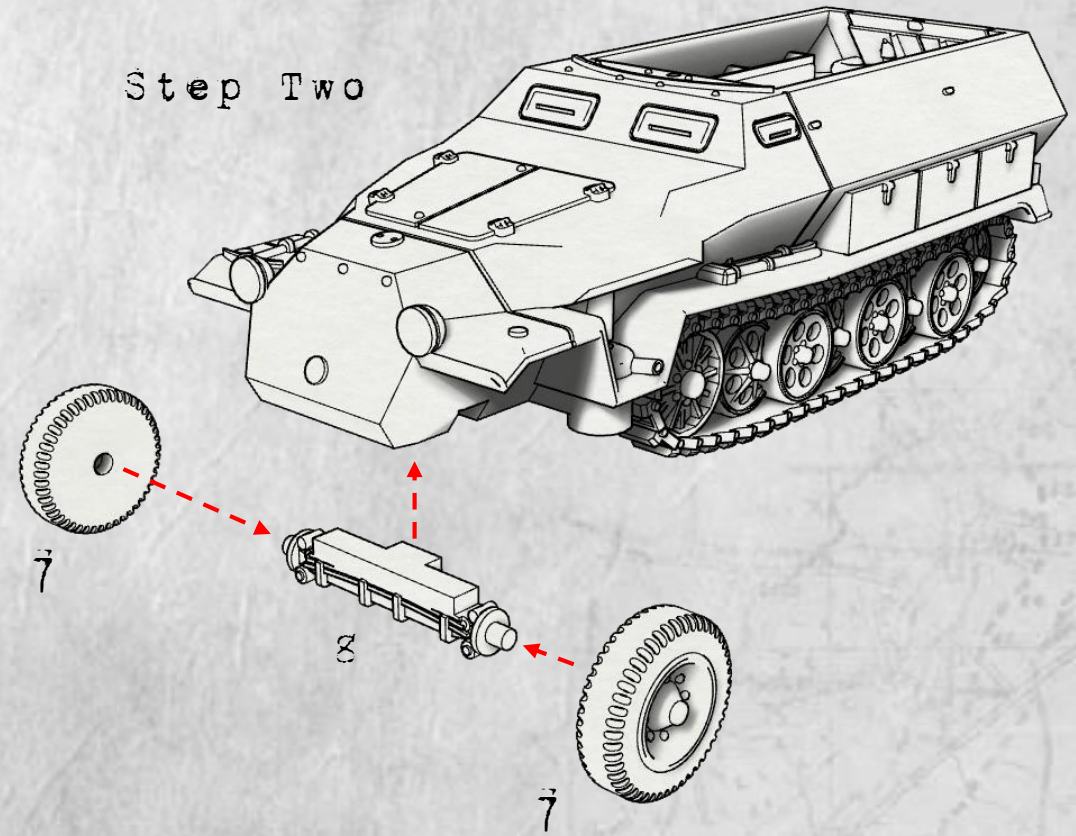

Trench Worx



Step Three

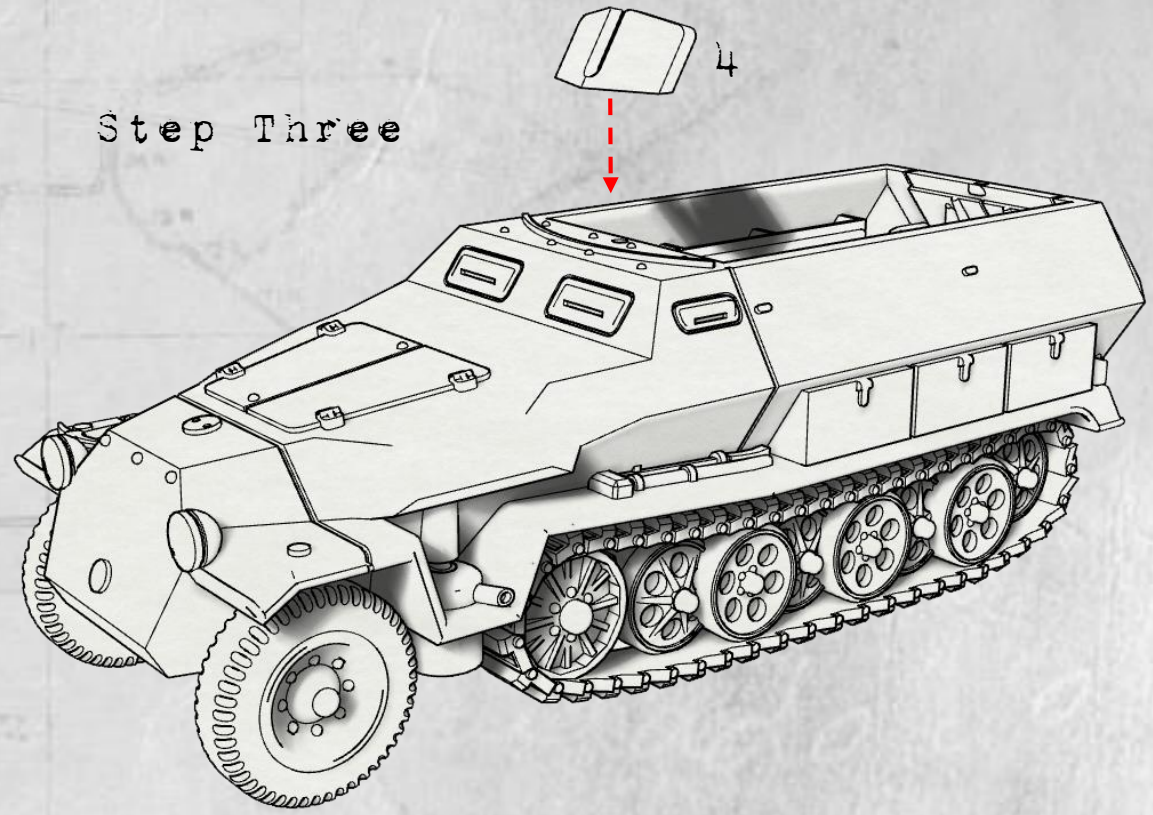

Step Four

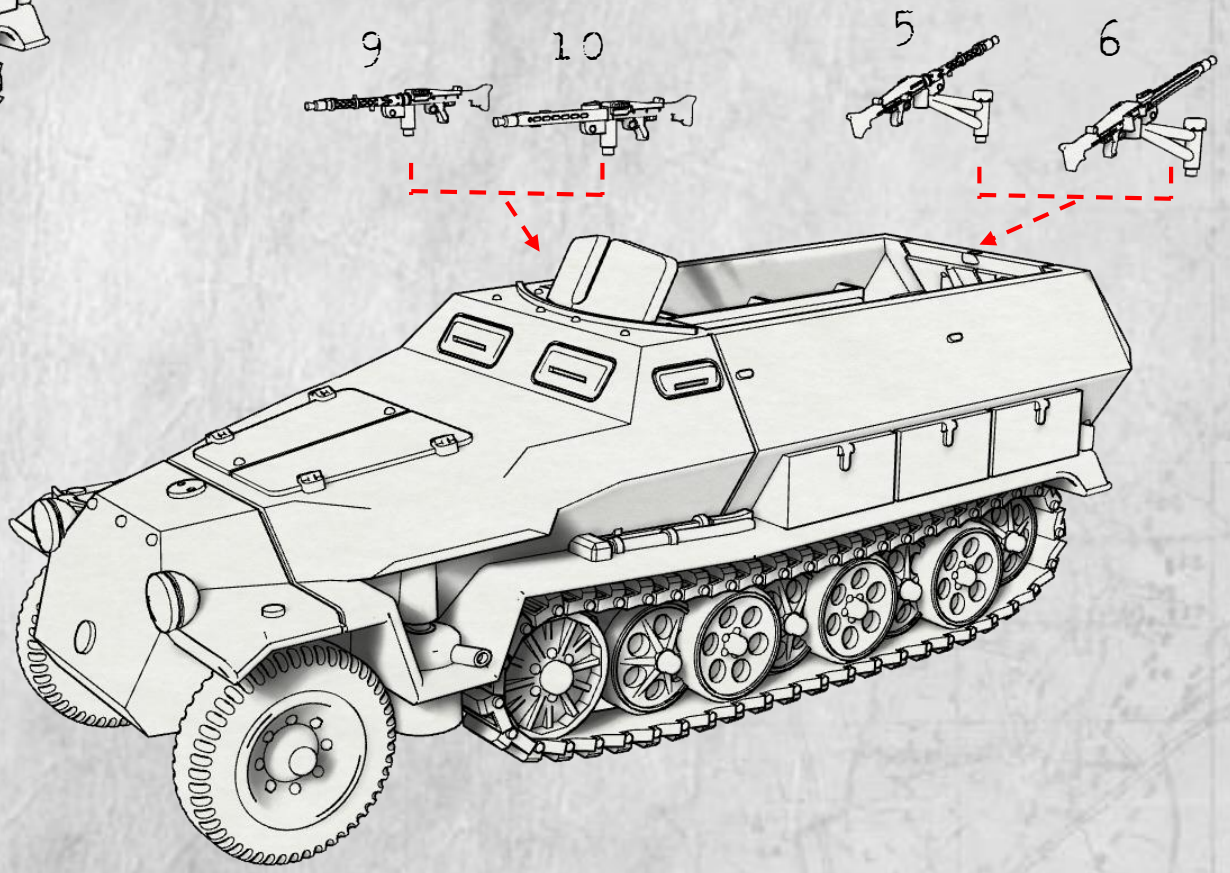

Trench Worx